

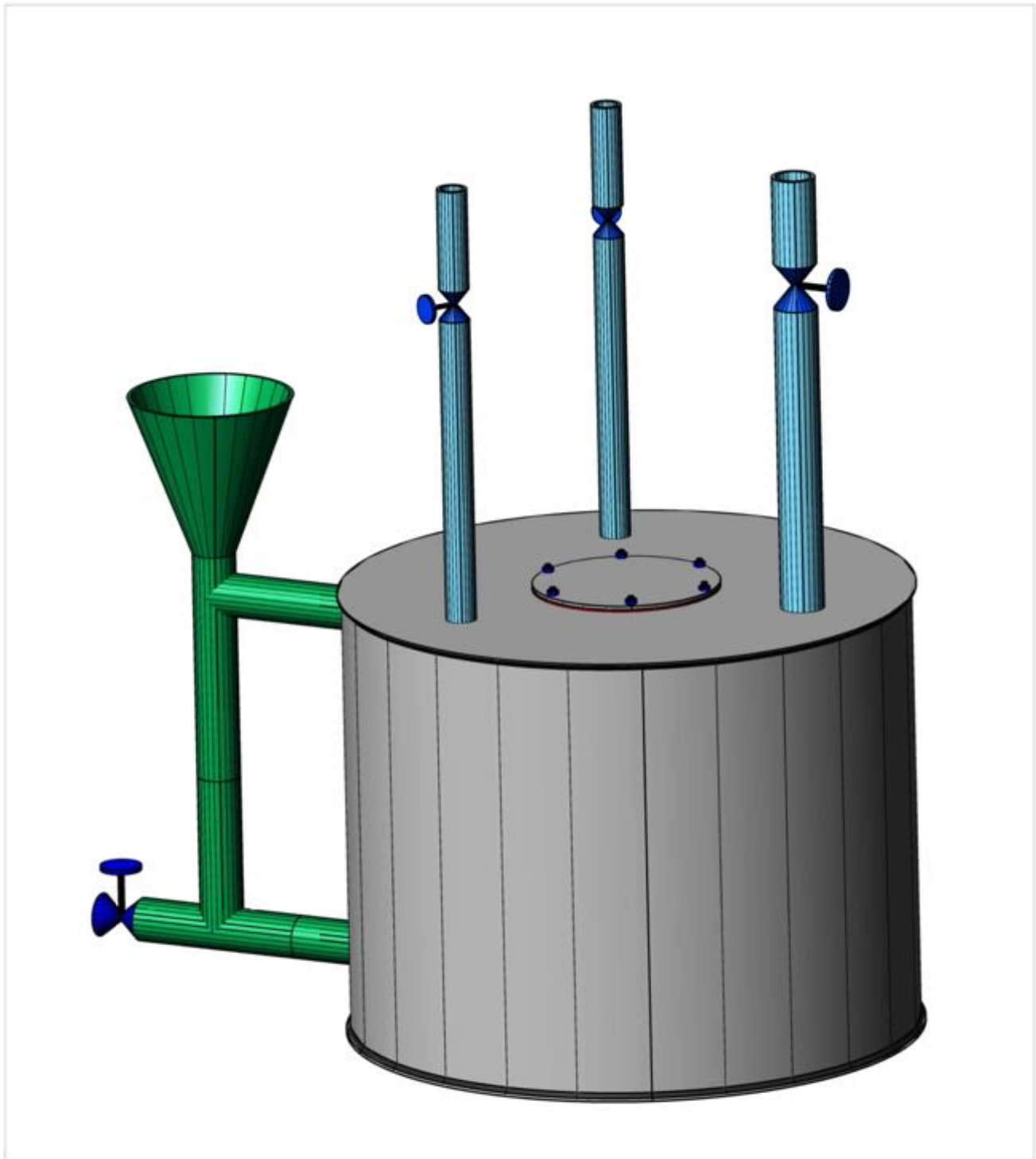



1	2	3	4
RevNo	Revision note	Date	Designed
			Checked
			Approved

3D VIEW





Itemref	Quantity	Title/Name, designation, material, dimension etc			Article No./Reference	
Designed by A. Carrea	Checked by E. Arato	Approved by - date Pongiglione - 30/06/08	File name Genvap	Date 30/06/08	Scale N/A	
 PS76 ONLUS		 AMIGOS DA GUINE BISSAU		 DICAT UNIGE		<h2 style="color: magenta;">BOILER</h2>
010-1-I-GDV-DGC-A				Edition 0	Sheet 1/9	

	1	2	3	4
RevNo	Revision note		Date	Designed
				Checked
				Approved

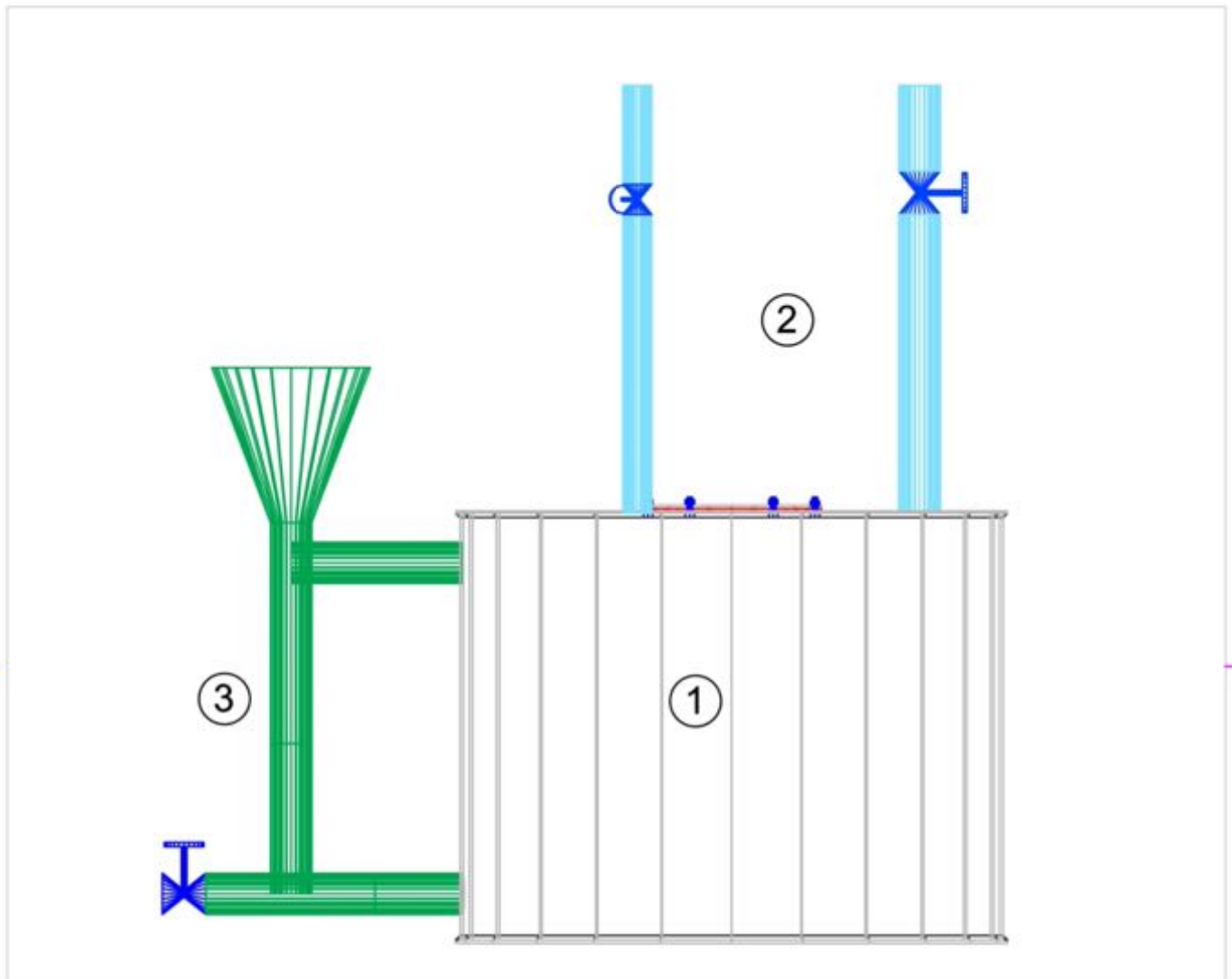
SIDE VIEW







ITEM	QUANTITY	DESCRIPTION	NOTES
1		wrapping (calendered sheet)	See sheet 5
2		Steam exit	See sheet 7
3		Drain, level and fill	See sheet 8

Itemref	Quantity	Title/Name, designation, material, dimension etc			Article No./Reference	
Designed by A. Carrea	Checked by E. Arato	Approved by - date Pongiglione - 30/06/08	File name Genvap	Date 30/06/08	Scale 1:8	
 PS76 ONLUS	 AMIGOS DA GUINE BISSAU	 DICAT UNIGE	BOILER			
			010-1-I-GDV-DGC-A			Edition 0

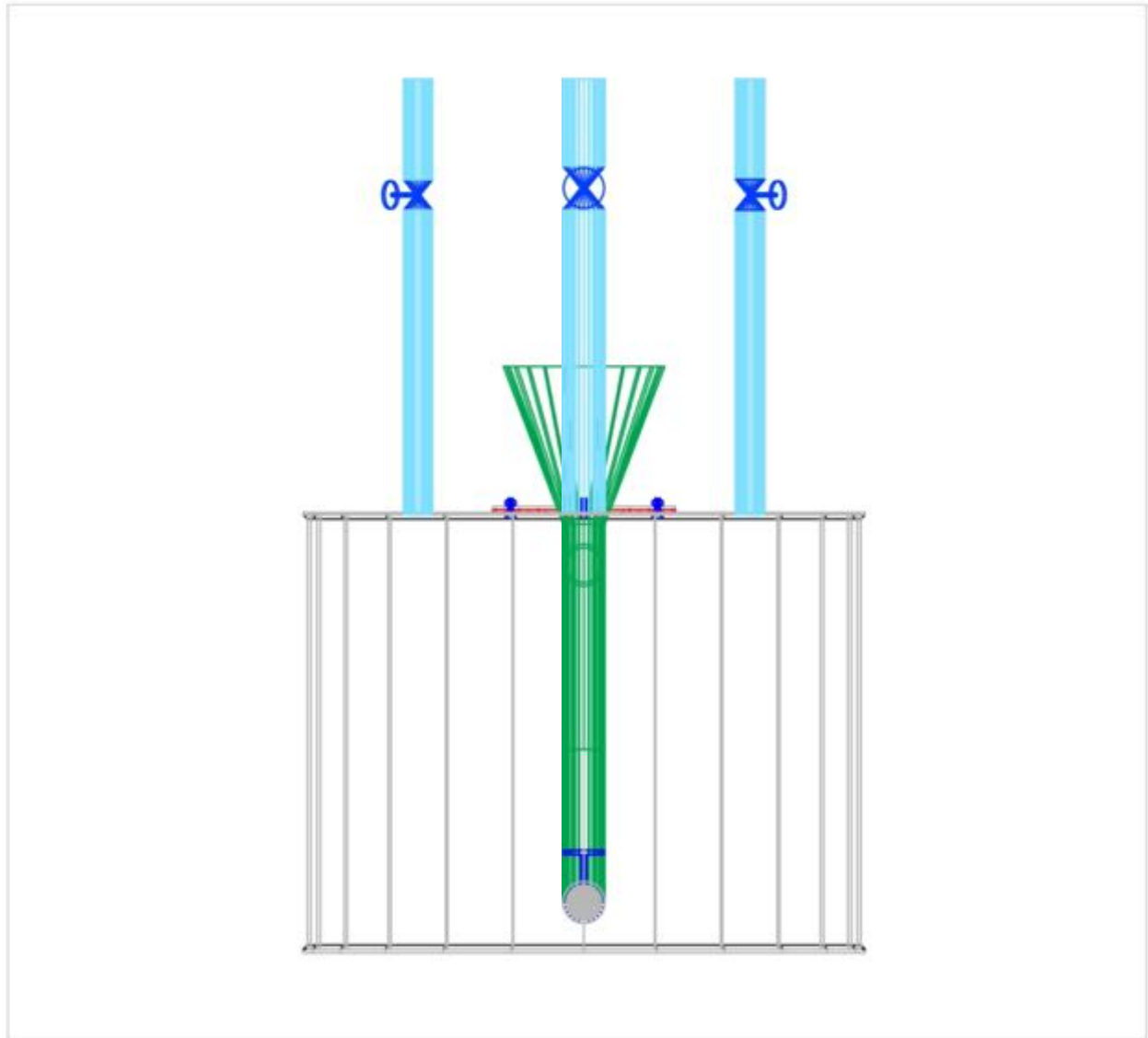
1	2	3	4
RevNo	Revision note	Date	Designed
			Checked
			Approved

FRONT VIEW





Itemref	Quantity	Title/Name, designation, material, dimension etc			Article No./Reference	
Designed by A. Carrea	Checked by E. Arato	Approved by - date Pongiglione - 30/06/08	File name Genvap	Date 30/06/08	Scale 1:8	
 PS76 ONLUS	 AMIGOS DA GUINE BISSAU	 DICAT UNIGE	BOILER			
			010-1-I-GDV-DGC-A	Edition 0	Sheet 3/9	

	1	2	3	4
RevNo	Revision note		Date	Designed
				Checked
				Approved

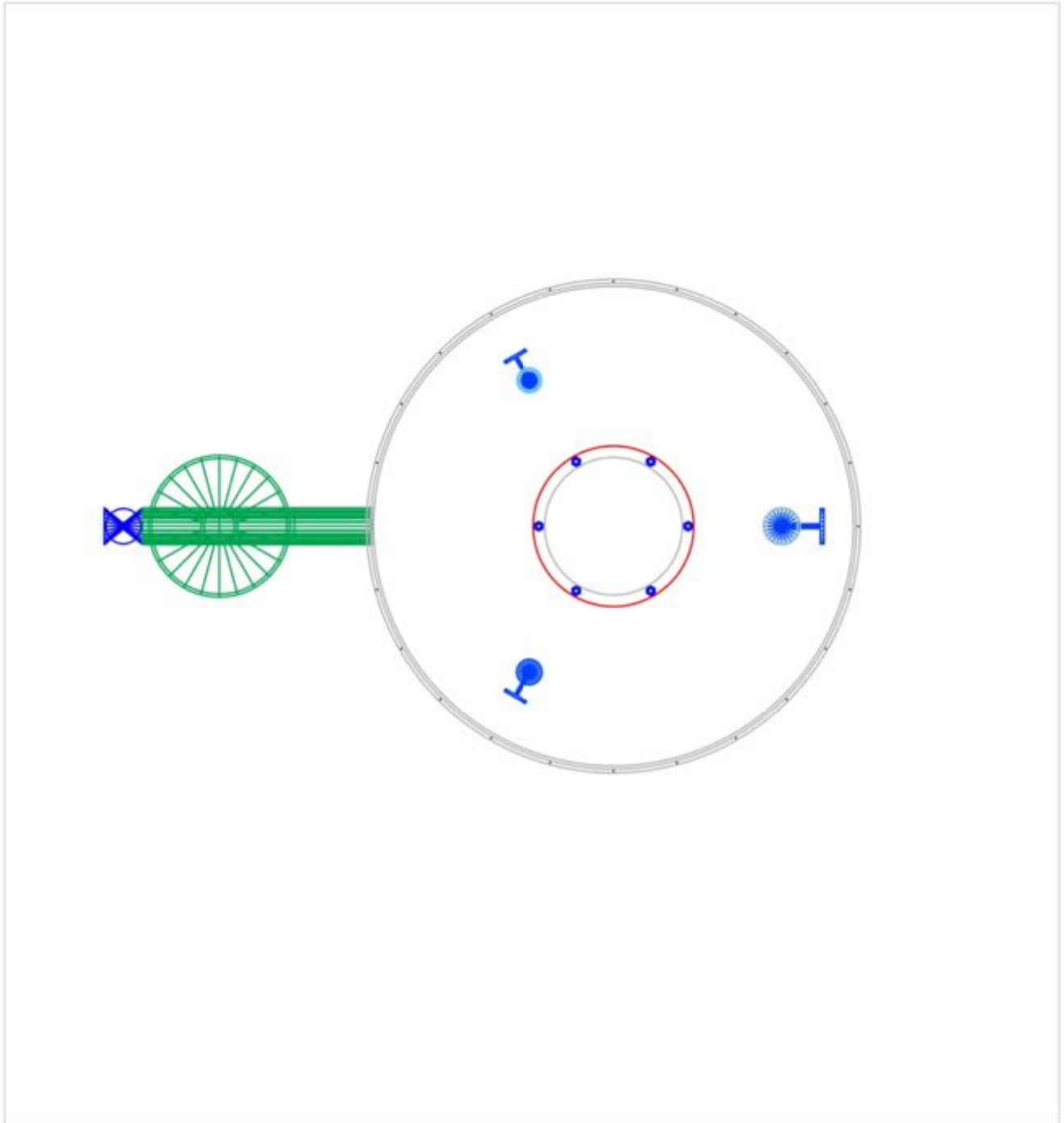
PLAN VIEW



Itemref	Quantity	Title/Name, designation, material, dimension etc			Article No./Reference	
Designed by A. Carrea	Checked by E. Arato	Approved by - date Pongiglione - 30/06/08	File name Genvap	Date 30/06/08	Scale 1:8	
 PS76 ONLUS	 AMIGOS DA GUINE BISSAU	 DICAT UNIGE	BOILER			
			010-1-I-GDV-DGC-A			Edition 0

1



4

	1	2	3	4
RevNo	Revision note		Date	Designed
				Checked
				Approved

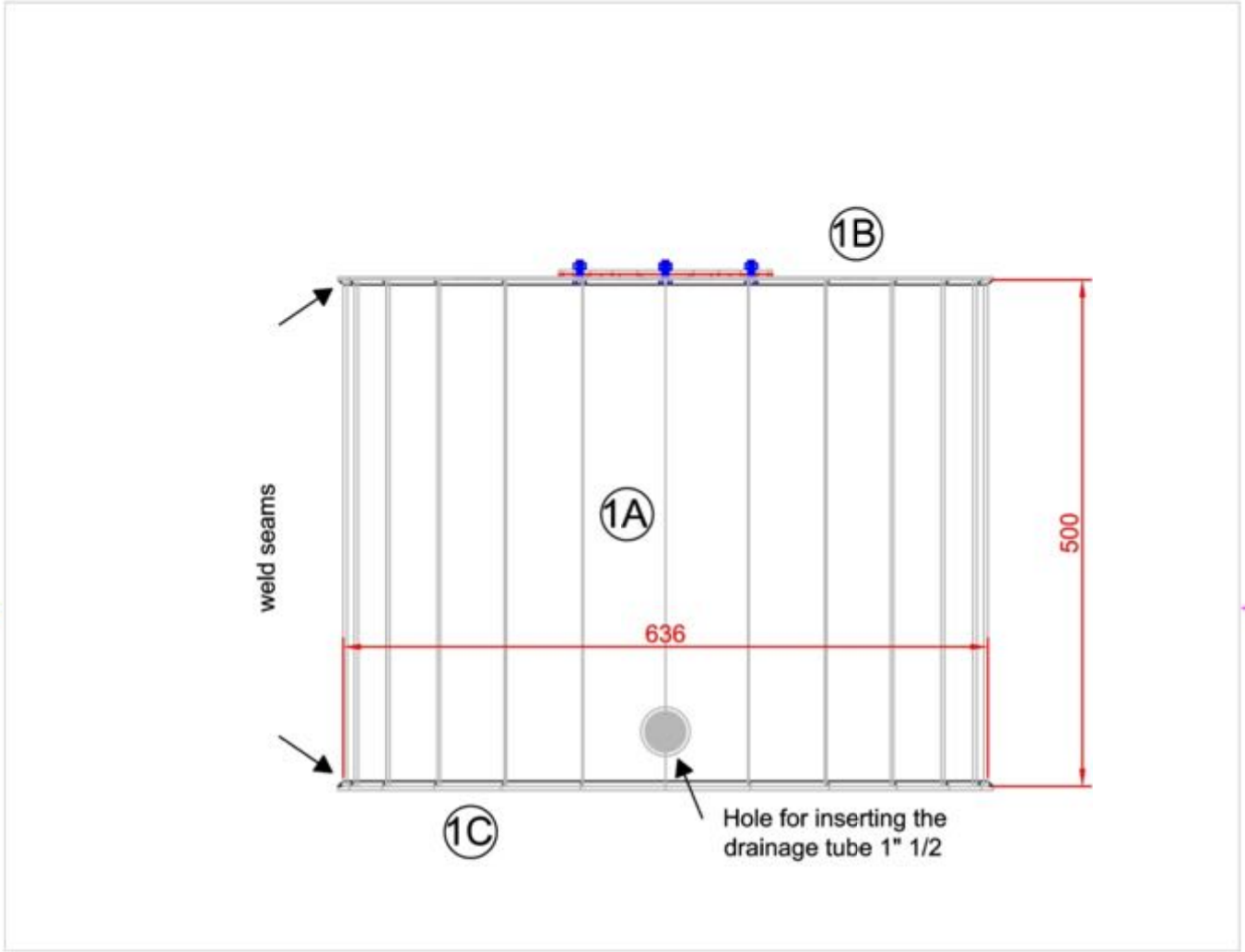
WRAPPING



ITEM	QUANTITY	DESCRIPTION	NOTES
1A	1	Plating	Carbon steel 2,5 mm th
1B	1	Cover	See sheet 6
1C	1	Bottom	Carbon steel 2,5 mm th

Itemref	Quantity	Title/Name, designation, material, dimension etc			Article No./Reference	
Designed by A. Carrea	Checked by E. Arato	Approved by - date Pongiglione - 30/06/08	File name Genvap	Date 30/06/08	Scale 1:8	
 PS76 ONLUS	 AMIGOS DA GUINE BISSAU	 DICAT UNIGE	BOILER			
			010-1-I-GDV-DGC-A			Edition 0

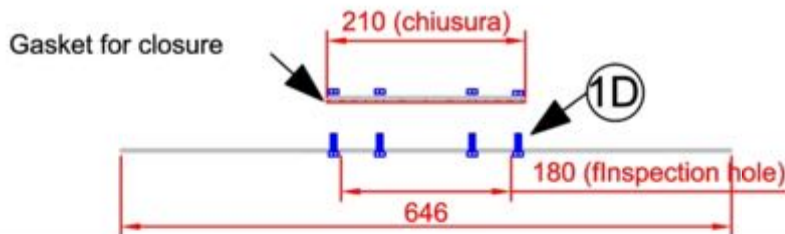
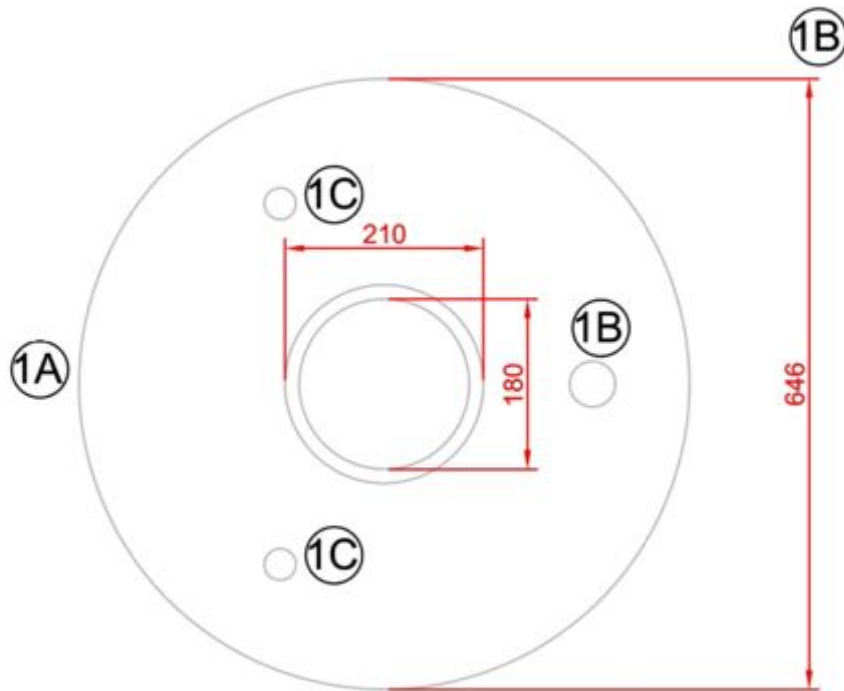

1	2	3	4
RevNo	Revision note	Date	Designed
			Checked
			Approved

WRAPPING (COVER)



ITEM	QUANTITY	DESCRIPTION	NOTES
1A	1	Cover	C. steel 2,5 mm th
1B	1	Hole for pipe 1" 1/2	
1C	2	Hole for pipe 1"	
1D	6	Bolts M6	Note 1

NOTE 1. The head of the bolts must be welded to the underside of the cover before welding the latter to the wrapping



Itemref	Quantity	Title/Name, designation, material, dimension etc			Article No./Reference	
Designed by A. Carrea	Checked by E. Arato	Approved by - date Pongiglione - 30/06/08	File name Genvap	Date 30/06/08	Scale 1:8	
 PS76 ONLUS	 AMIGOS DA GUINE BISSAU	 DICAT UNIGE	BOILER			
			010-1-I-GDV-DGC-A			Edition 0

1	2	3	4
RevNo	Revision note	Date	Designed
			Checked
			Approved

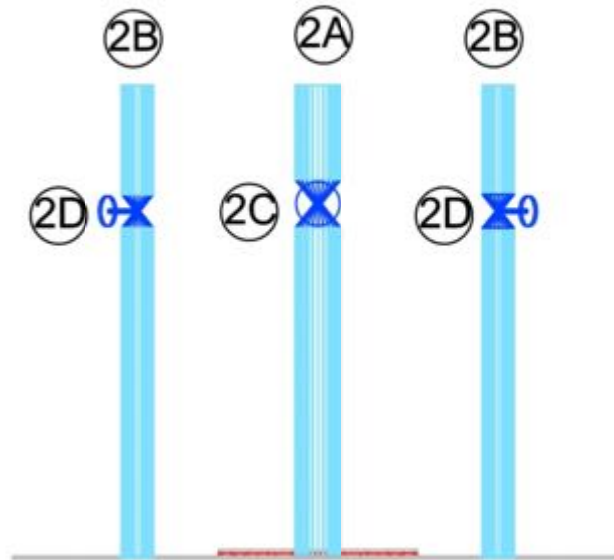
SEAM OUTLET



ITEM	QUANTITY	DESCRIPTION	NOTES
2A	1	Pipe 1" 1/2	Steam to Sterilizer
2B	2	Pipe 1"	To Clarifier and vent
2C	1	Valve 1" 1/2	Ball valve
2D	2	Valve 1"	Ball valve



Itemref	Quantity	Title/Name, designation, material, dimension etc			Article No./Reference	
Designed by A. Carrea	Checked by E. Arato	Approved by - date Pongiglione - 30/06/08	File name Genvap	Date 30/06/08	Scale 1:8	
 PS76 ONLUS	 AMIGOS DA GUINE BISSAU	 DICAT UNIGE	BOILER			
			010-1-I-GDV-DGC-A			Edition 0

1	2	3	4
RevNo	Revision note	Date	Designed
			Checked
			Approved

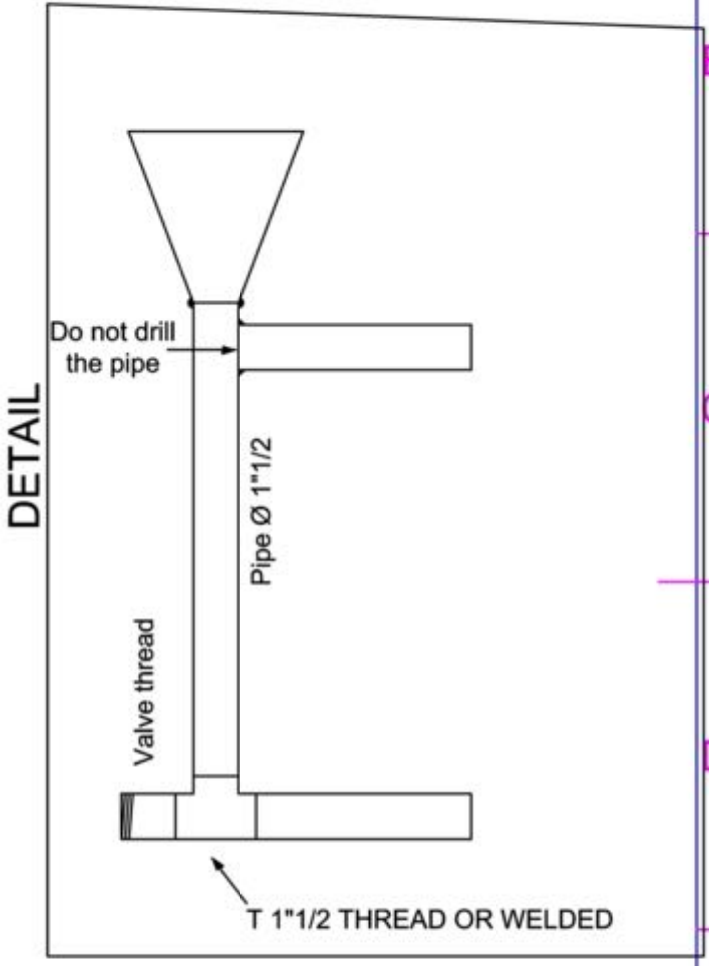
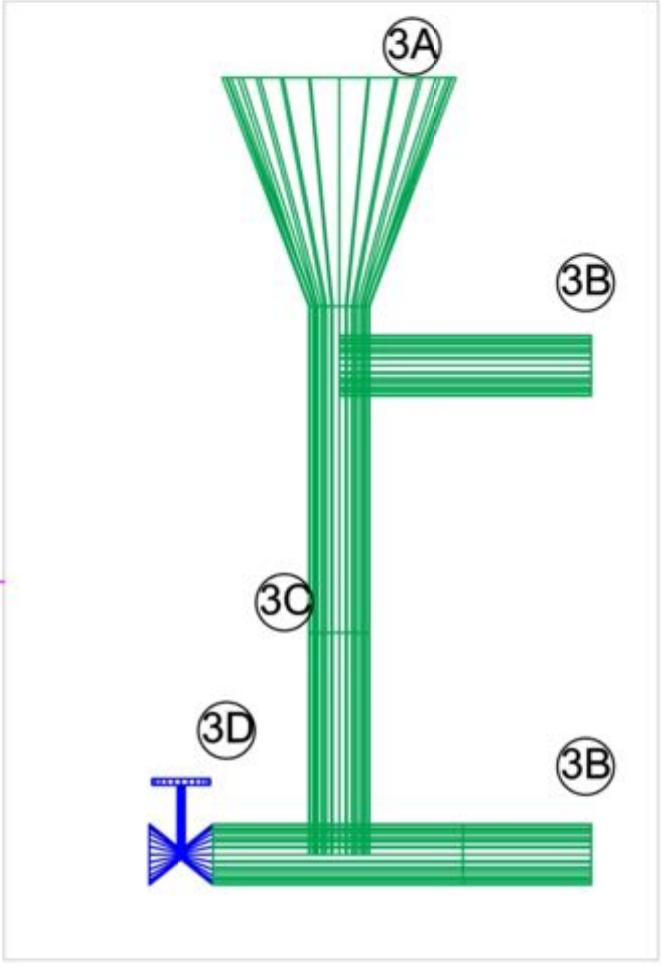
FILLING, DRAIN AND LEVEL







ITEM	QUANTITY	DESCRIPTION	NOTES
3A	1	Filling funnel	Carbon steel
3B	2	Pipe 1" 1/2	
2C	1	Pipe 1" 1/2	Carbon steel
2D	1	Valve 1" 1/2	

Itemref	Quantity	Title/Name, designation, material, dimension etc			Article No./Reference	
Designed by A. Carrea	Checked by E. Arato	Approved by - date Pongiglione - 30/06/08	File name Genvap	Date 30/06/08	Scale 1:6	
 PS76 ONLUS	 AMIGOS DA GUINE BISSAU	 DICAT UNIGE	BOILER			
			010-1-I-GDV-DGC-A			Edition 0

1	2	3	4
RevNo	Revision note	Date	Designed
			Checked
			Approved

GENERAL NOTES

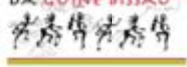
1. The dimensions not indicated can be obtained from the scale used in the single sheets. However, they are indicative and can be changed by the manufacturer to make construction easier
2. The thickness of the pipes is at the manufacturer's choice

Itemref	Quantity	Title/Name, designation, material, dimension etc	Article No./Reference
Designed by A. Carrea	Checked by E. Arato	Approved by - date Pongiglione - 30/06/08	File name Genvap
		Date 30/06/08	Scale 1:6
 PS76 ONLUS	 AMIGOS DA GUINE BISSAU 	 DICAT UNIGE	<h2 style="color: magenta;">BOILER</h2>
		010-1-I-GDV-DGC-A	Edition 0
			Sheet 9/9